



PROJECT DESCRIPTION:
MEDIUM BOWL PLANTER
LA1 20" dia x 11" tall

DRAWN BY:
V. TOSHANOVA
APPROVED BY:

SCALE:
DATE:
DWG NO:
REV DATE:

12665 116 Ave Surrey, BC V3V 3S6 Ph. 604-580-4108 toll free 800-671-8882 FAX. 604-580-4111 info@sandersonconcrete.com

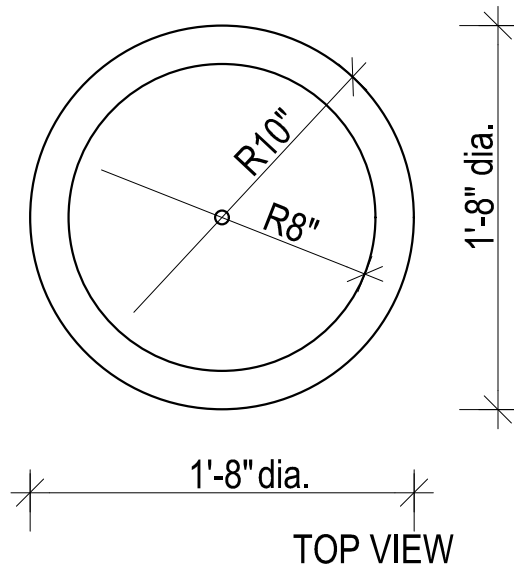
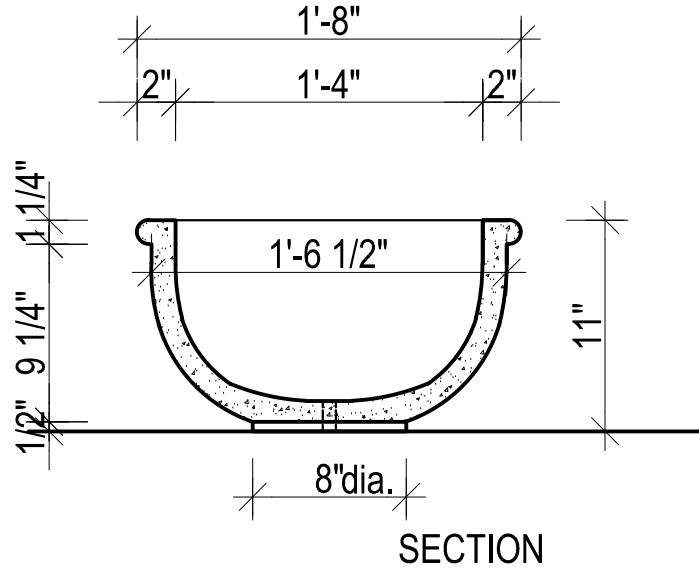

MEDIUM BOWL PLANTER	Diameter x Height	weight
LA1	20" X 11"	70 lbs